

Installation Manual

STREET MOTIF





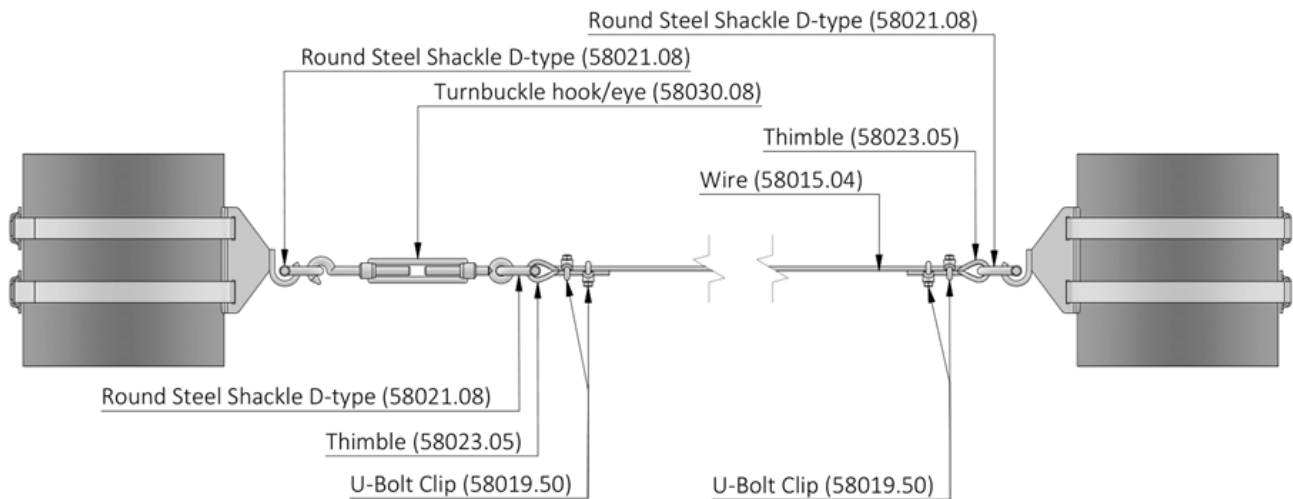

ADAMLIGHTS[®]

INSPIRED BY NORTHERN LIGHTS

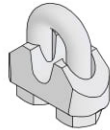
Product fixture parts



Part name:	Picture	Item code:	Quantity per one motif:	Total quantity:
U-Bolt Clip DIN 741 6 mm		58019.60		
Snap Hook DIN 5299 C 60 x 6 mm		58050.50		
Hanging wire assemblies 500 mm		52134.05		
Hanging wire assemblies 1500 mm		52134.15		

Product fixture parts are shown in the table below:

Tool name	Picture	Item code:	Total quantity
Ratchet tool 7mm and 8mm		-	

Installation Manual

STREET MOTIF



ADAMLIGHTS®

INSPIRED BY NORTHERN LIGHTS

IMPORTANT NOTICE

Before handling or installing the product make sure to carefully read the whole manual!
Installation instruction for installing a wirerope over the street is available on: www.adam.ee/installation

STEP 1

Hang the motif using the hanging wire assemblies (52134.05). The hanging wire assemblies are connected to the motif and support wire with snap hooks (58050.50). (Figure 18)

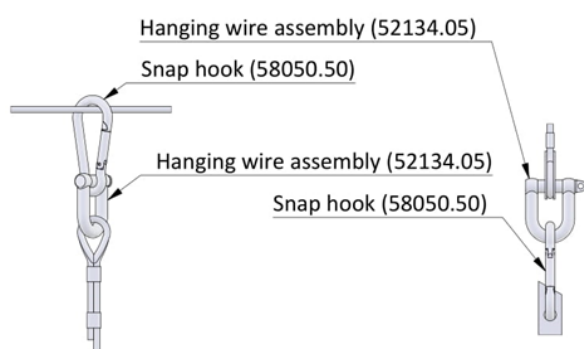

Figure 1- Step 1

STEP 2

After hanging the motif to the support wire use U-bolt clips (58019.60) to lock the snap hooks into place. (Figure 19)

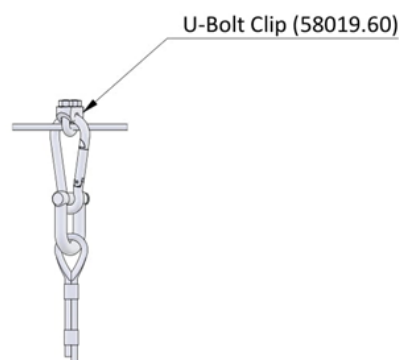

Figure 2 - Step 2

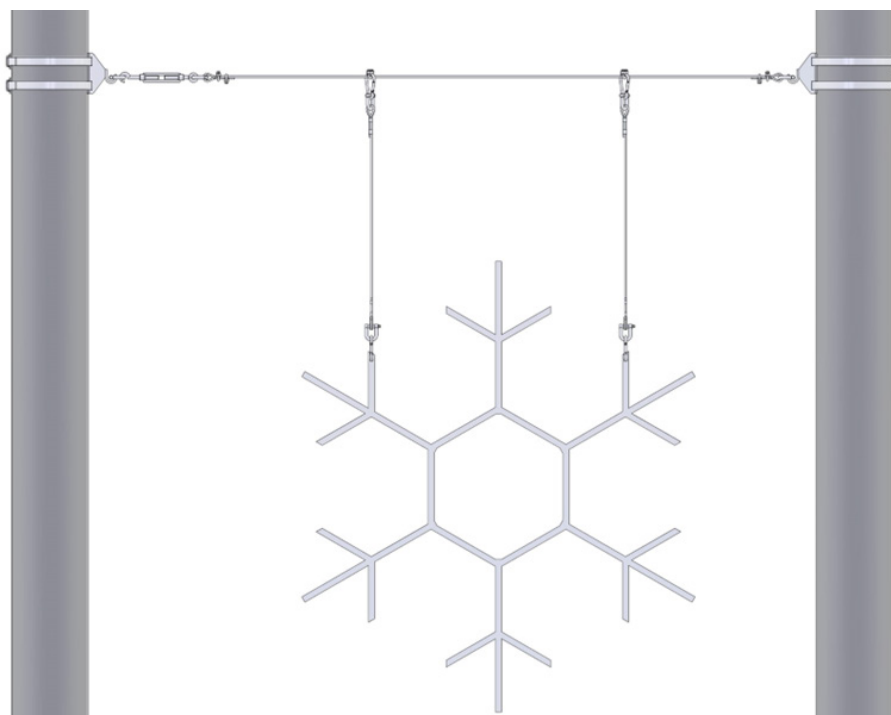

Figure 3 - Fixed motif

Installation Manual

STREET MOTIF



ADAMLIGHTS®

INSPIRED BY NORTHERN LIGHTS

General information

This instructions manual (Original instructions) gives an overview of the STREET MOTIF. The manual includes information about the manufacturer, intended use, installation, handling and maintenance of the product.

To get familiar with the product, we insist that you read our instructions very carefully, even if you have worked with a similar product before. These instructions contain information that is essential to ensure safety and efficiency when working with the product.

When receiving the product, make sure that it is not damaged during shipping or transportation. If you notice any damage or lack of parts, please contact the manufacturer immediately.

Any questions regarding the product or its working principle should be directed to the manufacturer. Reading and understanding the content of this manual is mandatory to anyone performing maintenance, installing or handling the product.

When handling, maintaining and installing the product and its various parts, all applicable national laws, regulations, and the contents of this manual must be taken into account to ensure the safety and reliability of the equipment.

During the handling and maintenance of the product, personal protective equipment must be used. Use of at least work gloves, safety boots and safety helmet is required.

Additional protective equipment must be used if the need arises.

When working with tools or machines producing large amount of noise, appropriate noise protection equipment must be used.

When using a ladder or a lift to install the product, the personell must have necessary training and qualifications to use the work equipment.

During installation the safety of the personell and bystandards must be ensured.

Before making any electrical connections make sure that installation process has been done correctly. Make sure there are not any dents or irregularities to the product, fixtures or electrical wires.

All installation steps must be followed exactly and in the correct order.

During maintenance make sure that visual assessment does not reveal any excessive wear of the components.

All maintenance must be carried out by persons with the appropriate skill and technical competence. Changing the construction of the product, adding or removing parts is only allowed after consulting with the manufacturer.

During utilization all structural and electrical parts must be separated by material and brought to the appropriate reveiving point.

The product must only be used for the operations intended for it. It is strictly forbidden to use the product for non-intended operations or uses.

Following the manual is a requirement to ensure that the factory warranty remains.

Ignoring safety instructions and requirement can result in damage of the users' health and/or bodily injury.

Manufacturer
ADAMLIGHTS AS
Järvevana tee 9, 11314 Tallinn, Estonia
sales@adam.ee
+372 6501830
www.adam.ee